



Training slides on securing loads safely

This set of slides is created for transport operators. You can use it to complement your company's in-house Workplace Safety & Health (WSH) training.

Various types of loads and good load-securing practices are illustrated with diagrams and pictures in the slides and you can customise it by selecting the loads relevant to your company's operations.

Your company
logo here

SAFE LOADING ON VEHICLES

Date

Content

1. Workplace Safety and Health (WSH) Policy
2. Employee's Roles and Responsibilities
3. Types of Vehicles
4. Fittings for Securing Loads
5. General Guide on Securing Loads
6. Securing Methods for various loads:
 - Tyres
 - Boxes
 - Sacks/Bags
 - Bales/Bundles
 - Drums
 - Empty pallets
 - Palletised cargo
 - Metal loads
 - Steel Plates/Structural steel
 - Pipes
 - Ingots/Bars
 - Metal sheet coils
 - Steel wire coils
 - Cable drums
 - Metal panels
 - Scrap metal
 - Timber loads
 - Heavy machines/equipments
 - Containers
 - Precast
 - Concrete blocks/slabs
 - Jumbo bags
 - Car transporters
 - Tote bins

Insert company
logo



1. WSH Policy

Insert your company's
WSH Policy here

Insert company
logo



2. Employee's Roles and Responsibilities

1. Follow all safe work procedures and instructions
2. Report all unsafe work conditions and work practices to your supervisor

3. ...

4. ...

5. ...

6. ...

7. ...

8. ...

Please add your company's own
WSH rules and regulations here

Insert company
logo



3. Types of Vehicles

- Use the right vehicle for transporting the load
- Ensure vehicle is long enough, such that loads do not stick out
- Ensure vehicle and load do not exceed maximum laden weight
- Ensure vehicle has proper fittings for securing loads

Low bed trailer



Lorry with sideboard



Mini truck



Insert company
logo

4. Fittings for Securing Loads

Headboard

- Prevent loads from breaching driver cabin
- Height reference when stacking loads
- Strong enough to bear the weight of loads



Stanchion

- Barrier for keeping loads within lorry bed
- Height reference when stacking loads
- Strong enough to bear the weight of loads
- Minimum number of stanchions needed
 - 20-foot trailer, at least 2 on each side
 - 40-foot trailer, at least 4 on each side



Insert company
logo

4. Fittings for Securing Loads

Anchorage points & load securing devices

- Check working condition before using
- Replace worn out or damaged devices
- Keep devices well-maintained

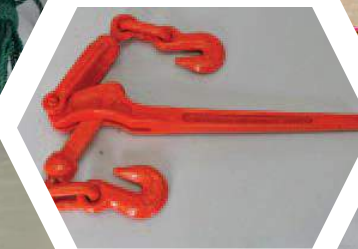
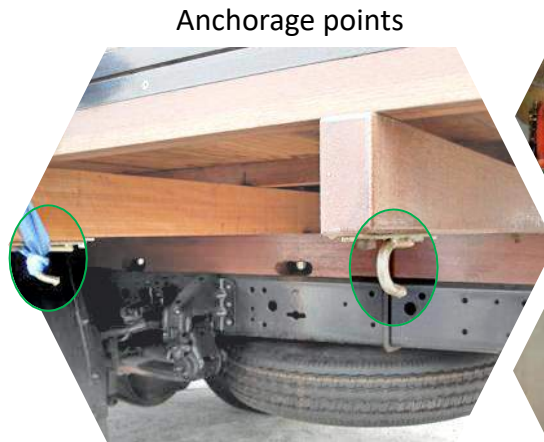

Insert company logo

5. General Guide on Securing Loads

Stacking

- Stack lighter loads on top of heavy loads (Figure A)
- Arrange loads to spread the weight out evenly (Figure B)
- Ensure that stacking arrangement is stable

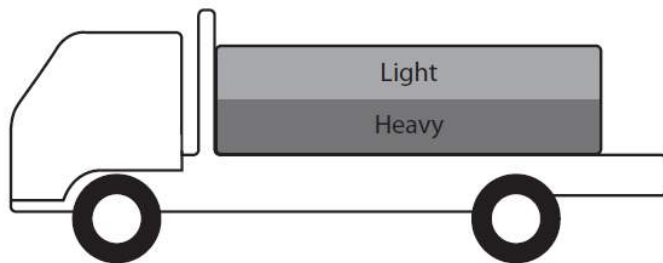

Figure A

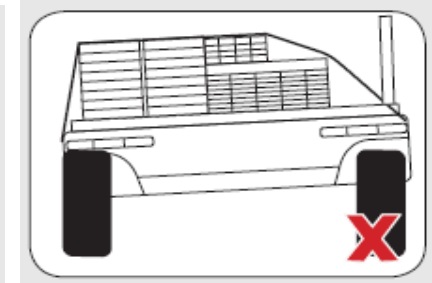
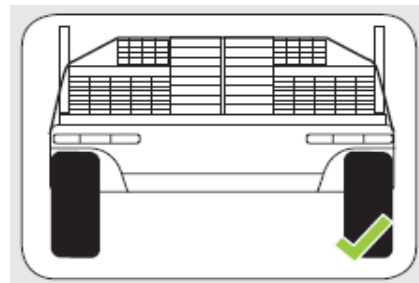
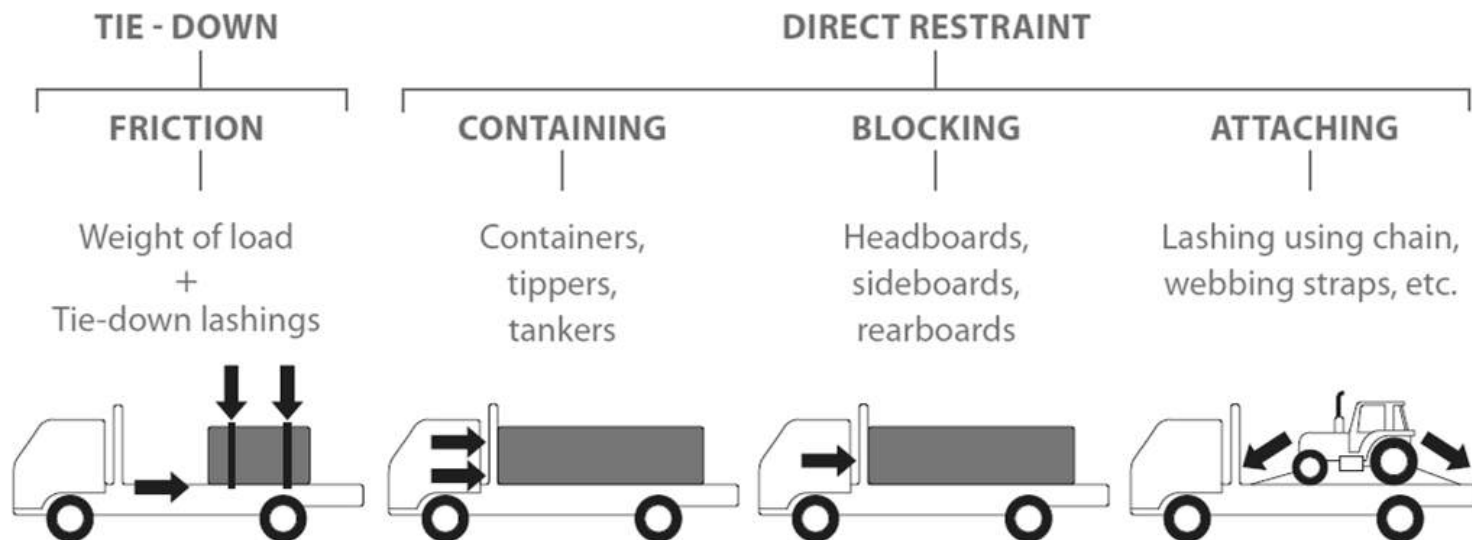

Figure B

5. General Guide on Securing Loads

Securing

- Check lashings for damages before use
- Bundle loose loads tightly together
- Secure and contain the loads properly
- Use friction mats to reduce movement



Insert company logo

Tyres

- Ensure a headboard is installed on vehicle
- Shrink wrap every column of tyres
- Lash every row of tyres to the vehicle

Side view:

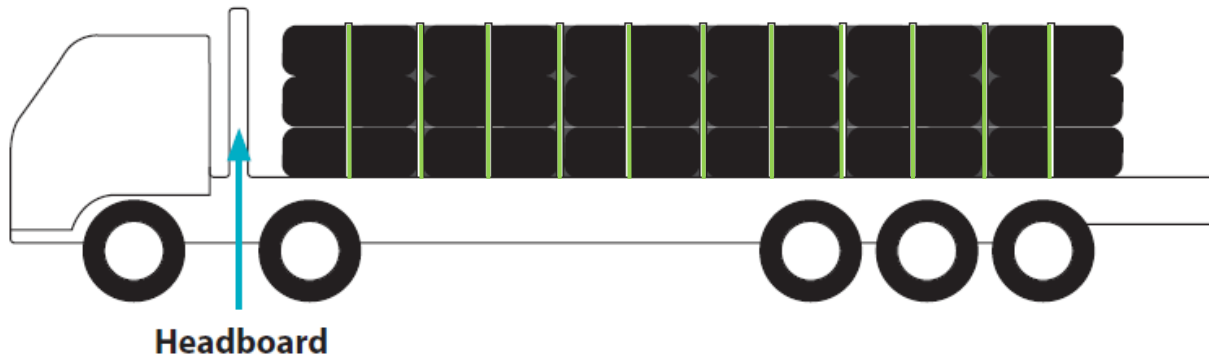

Top view:

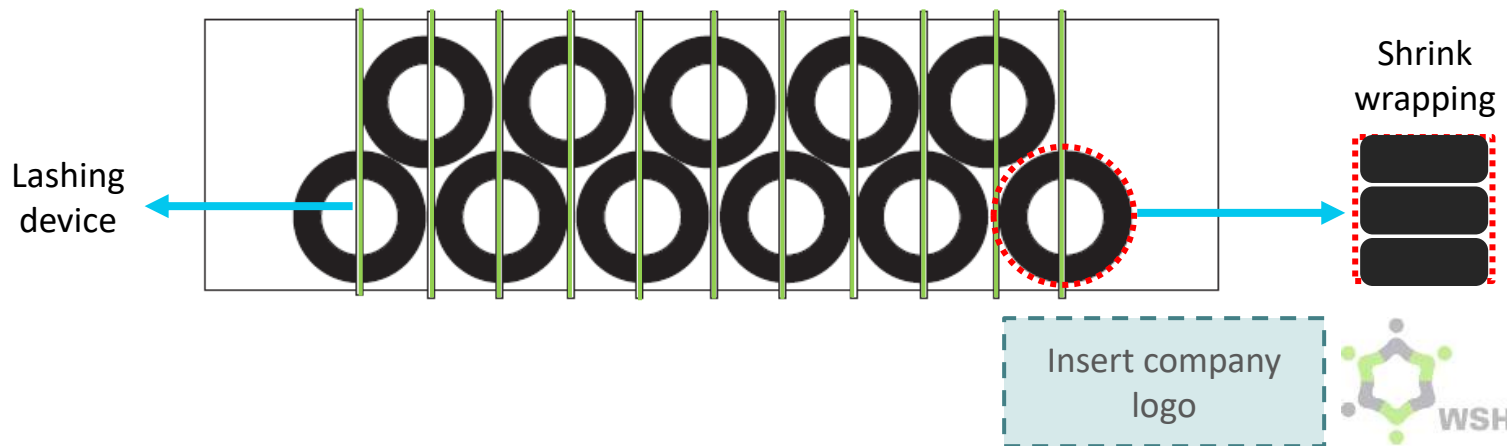

Boxes



- Pack boxes as closely as possible
- Lash all rows of boxes to the vehicle
- Use at least 1 lashing device per 1.5m of box length

X Lashing only on one row of boxes

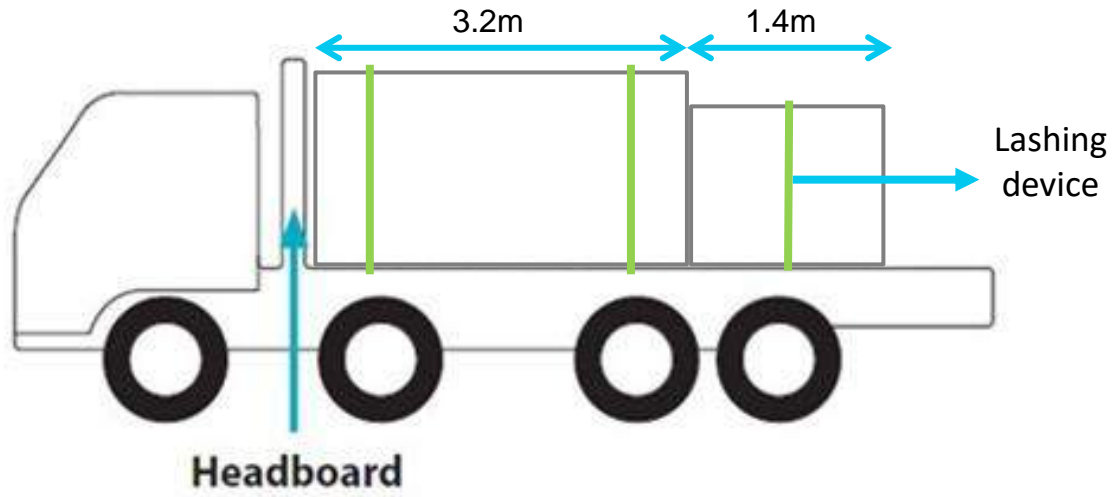

Insert company logo



Sacks/ Bags

- Place alternate layers in opposite directions
- Strap or wrap each stack to a pallet
- Lash every single row
- If load is not secured to pallet, do not stack the load, and cover the loads with a canvas sheet

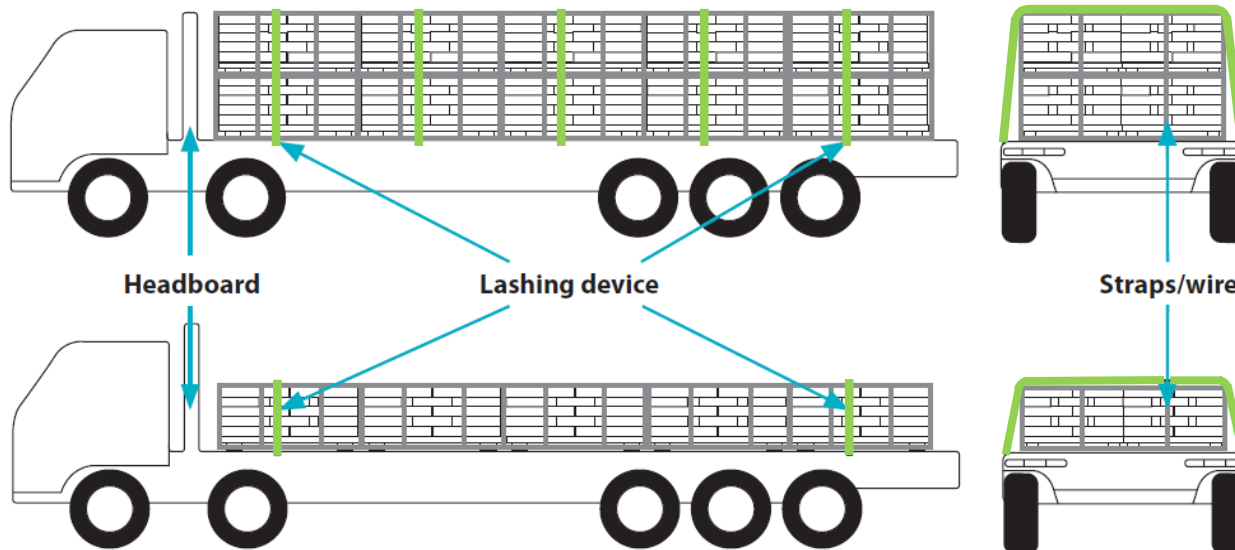

Insert company
logo

Bales/ Bundled loads



- One layer: lash the first and last row
- Two or more layers: lash all rows

✗ Insufficient lashing
in both examples

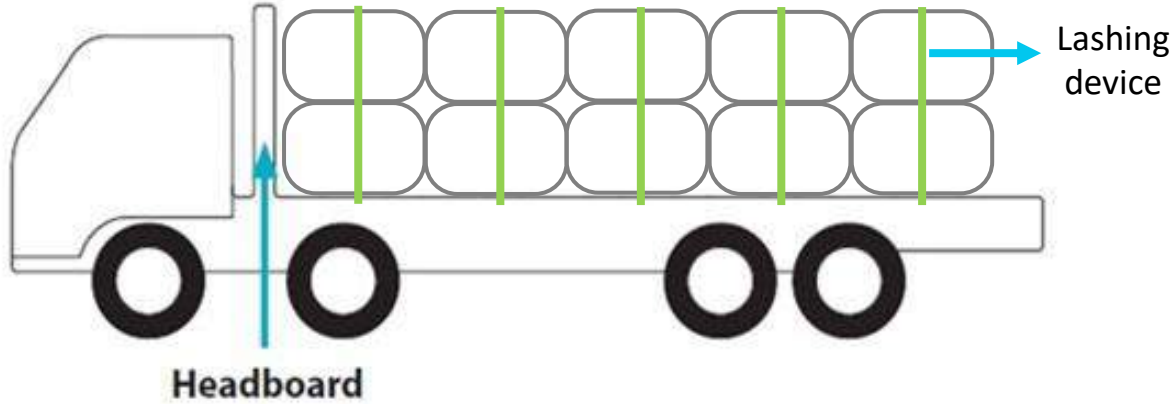

Insert company
logo



Drums

Drums standing vertically

- Load drums on pallets tightly together
- Bundle drums on the same pallet with lashing
- Secure lash lines above middle of drums
- Lash the first and last rows of drums

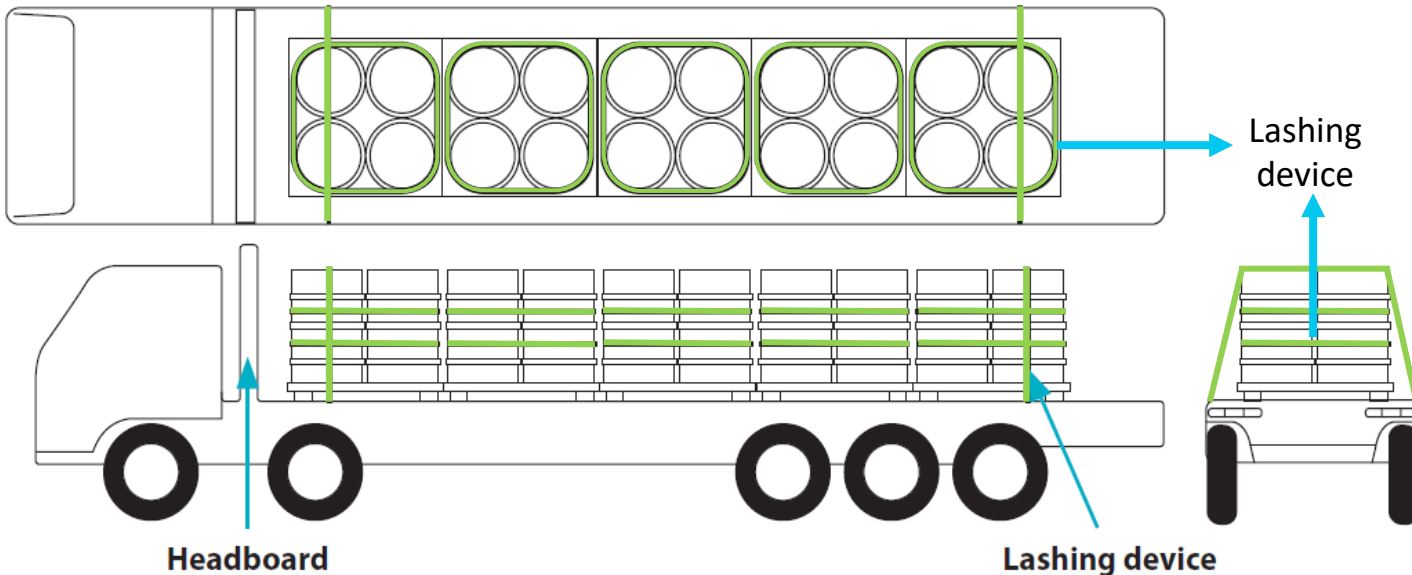

Insert company
logo



Drums

Drums lying horizontally

- Ensure stanchions or tailboards are fitted at tail of trailer
- Lay drums across the vehicle so they only roll forward or backward
- Ensure all drums are in contact with the drums beside them
- Chock the first and last row to reduce movement

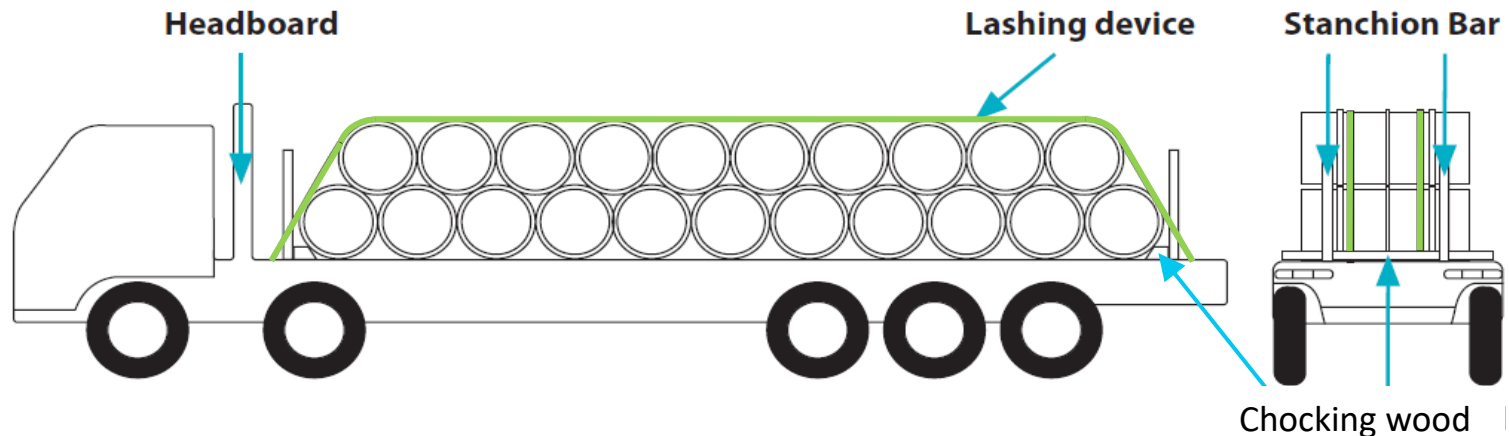

Insert company logo



Empty pallets

- Pack the pallets tightly together
- Lash every row to reduce movement

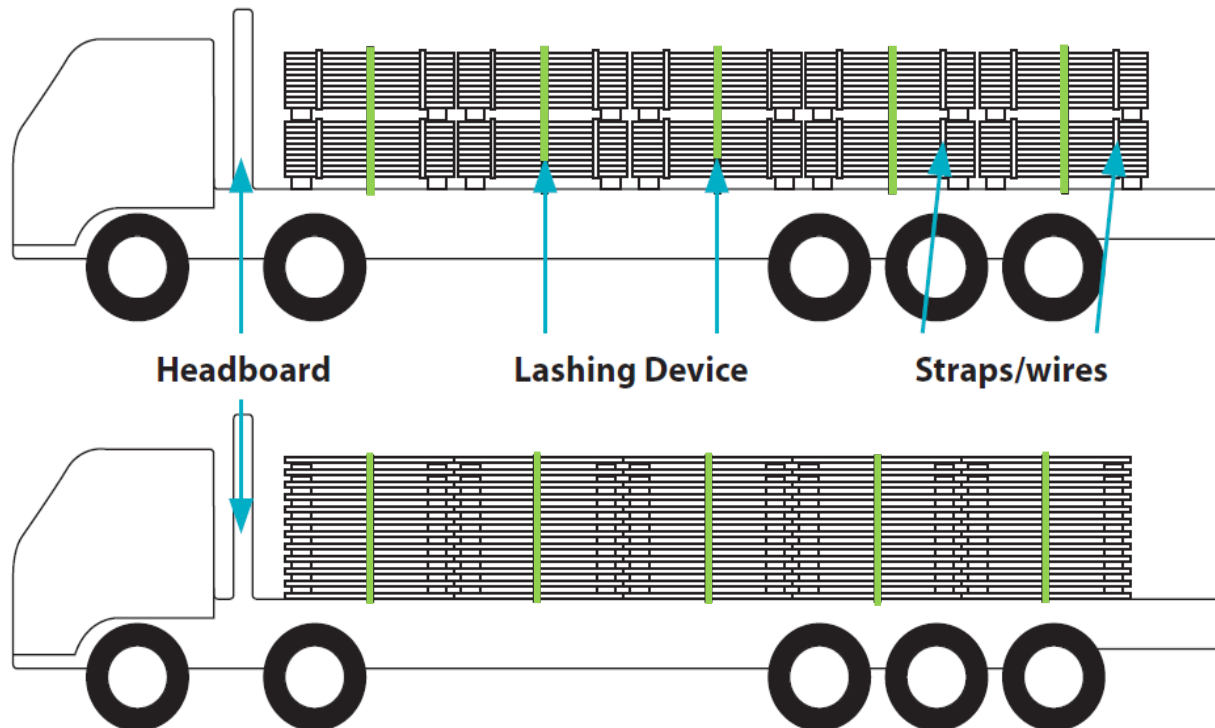

Palletised cargo



- Check working condition of pallets
- Stack cargo in a stable manner on the pallet
- Shrink wrap and secure cargo to the pallet
- Lash every row of pallets

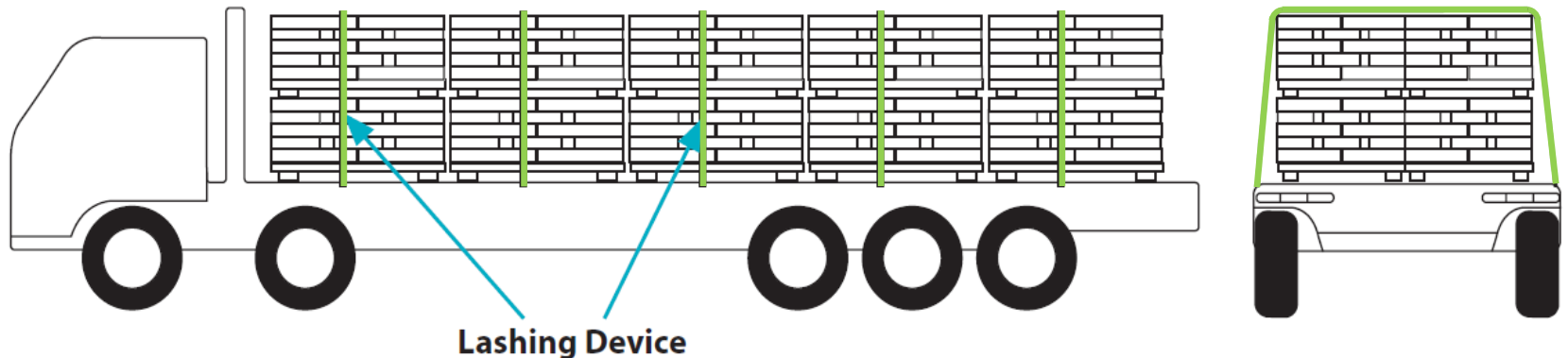

Insert company
logo



Steel Plates/ Structural steel

Different-sized steel

- Place smaller steel pieces on top of larger, heavier ones
- Place spacers in between each stack
- Ensure that the stacks and spacers are in contact
- Use at least two lashing per stack

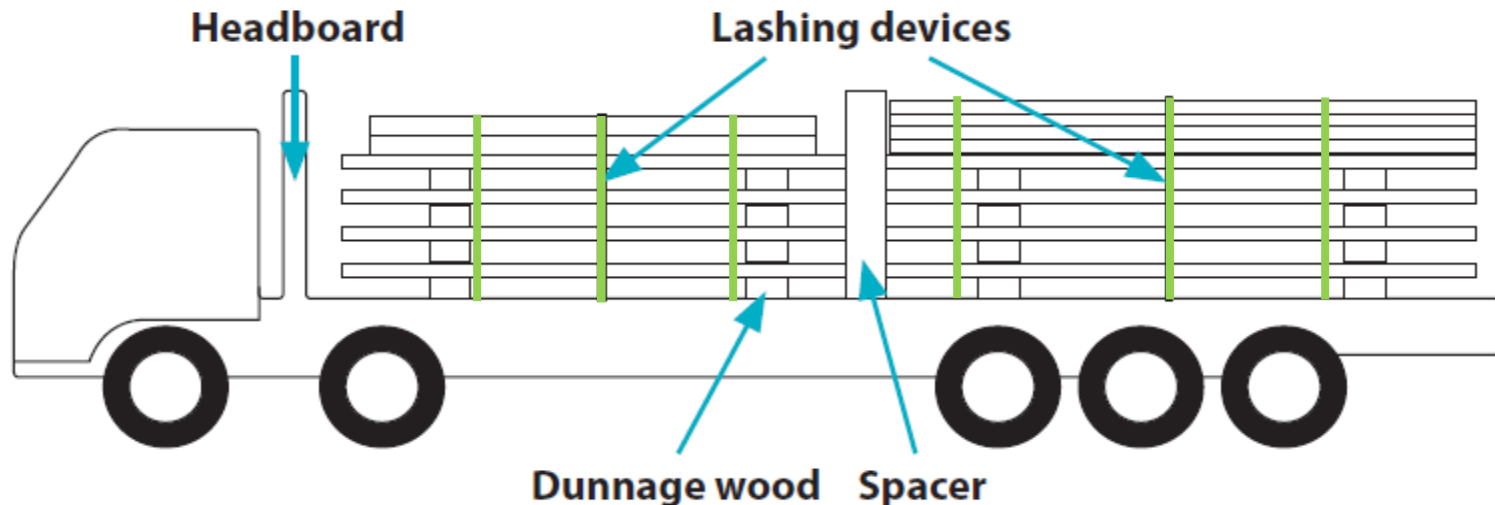

Insert company
logo

Steel Plates/ Structural steel

Structural steel

- Ensure enough stanchion bars are fitted on the lorry bed
- Use at least two lashing devices for each piece of steel
- Use more lashing devices when stacking in layers

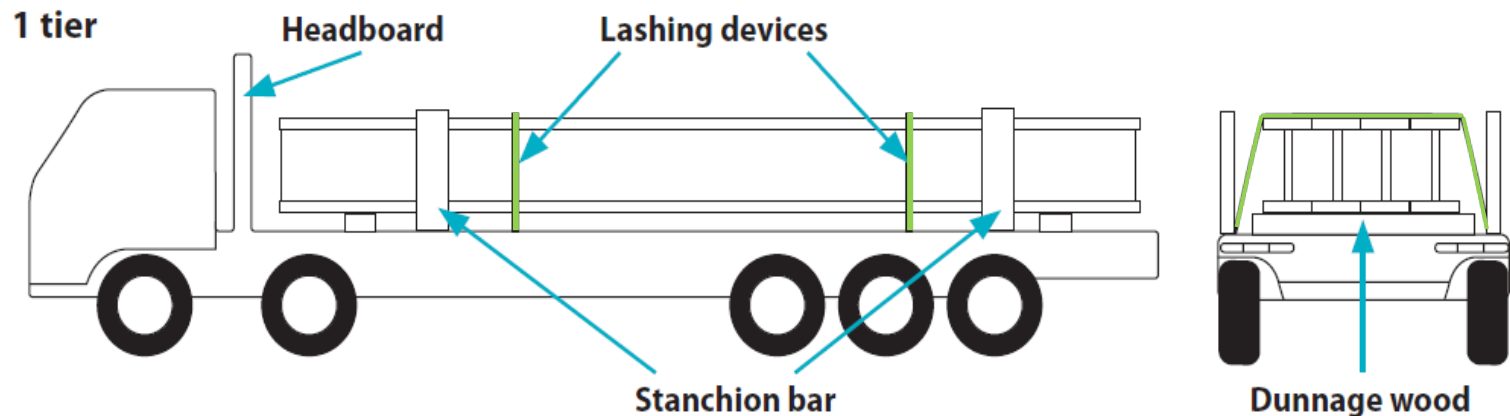

Insert company logo



Steel Plates/ Structural steel

Structural steel

- Ensure dunnage wood is in good condition, & lay it between layers
- Ensure at least two stanchion bars on each side per stack of steel
- Use at least two lashing devices per stack

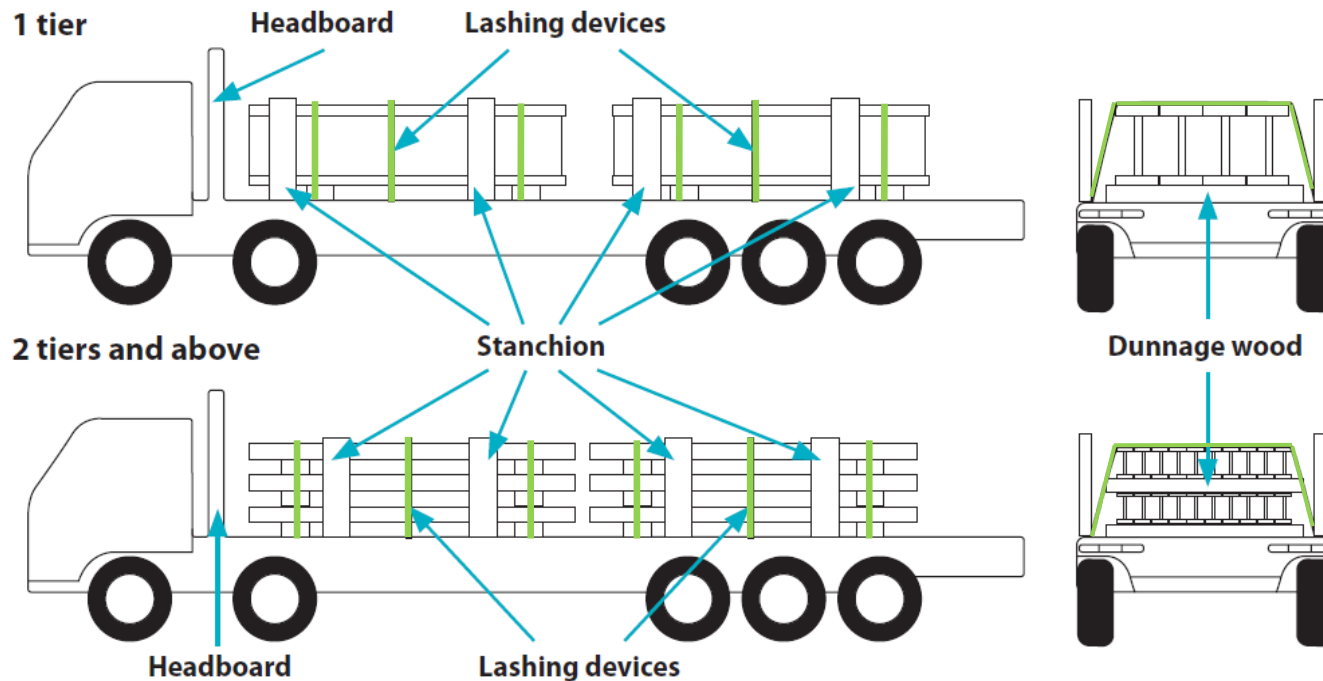

Pipes

- Use long trailers so the pipes do not hang out of the trailer
- Bundle loose pipes together
- Use at least two lashing devices per stack

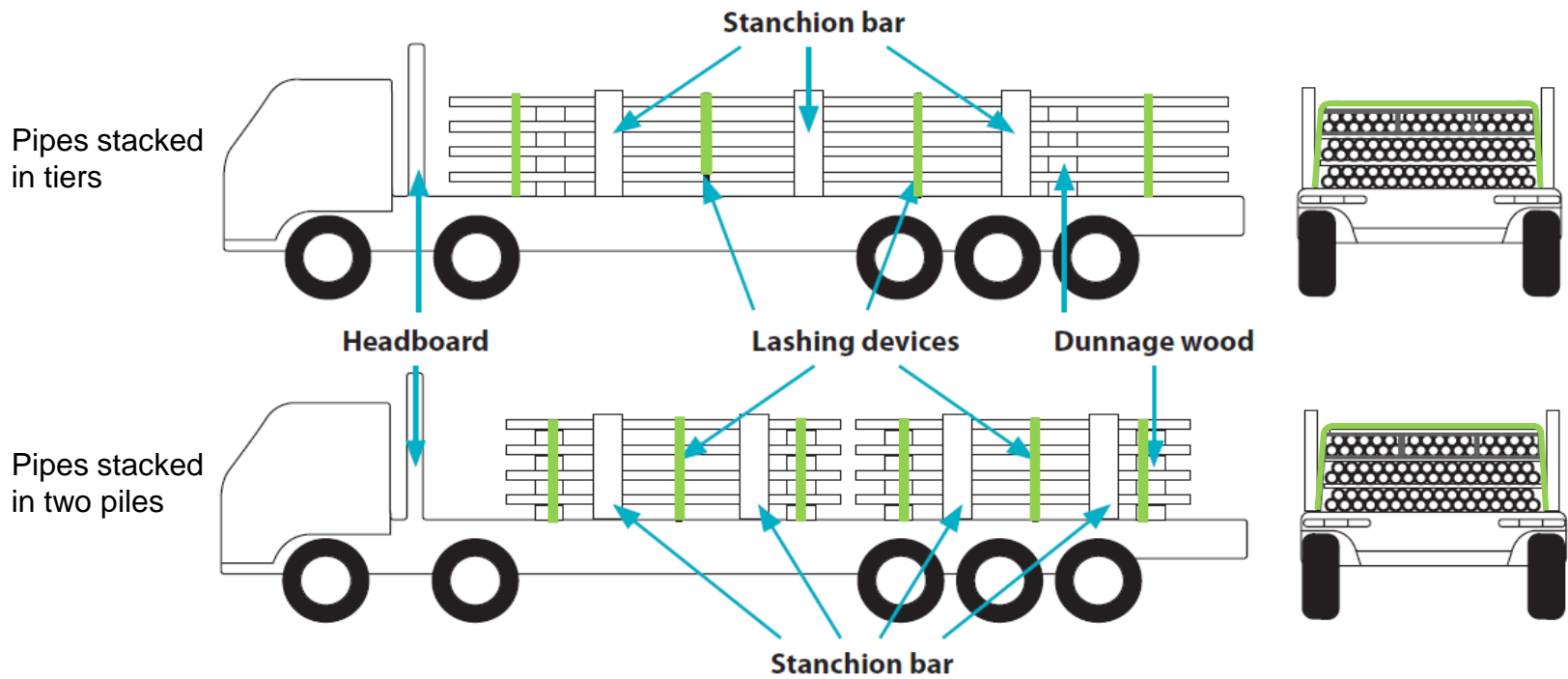

Insert company logo



Ingots/ Bars

- Tightly pack loads in a stable arrangement
- Fill empty spaces in between ingots with dunnage wood when applicable
- If empty spaces cannot be filled, wrap ingots to restrict movement
- Lash every row of ingots

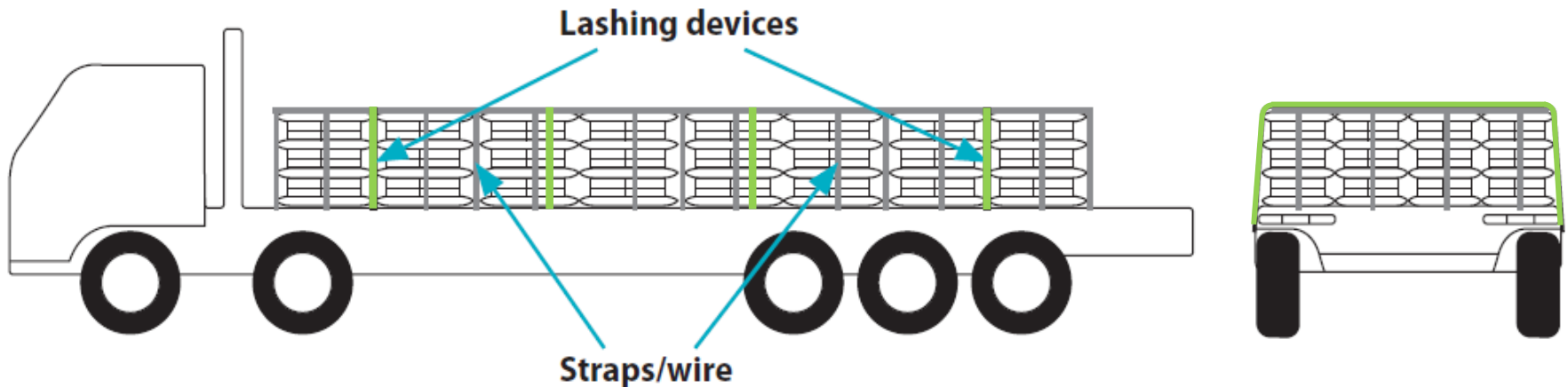

Metal sheet coils

Coils placed without pallets

Coils can be loaded along or across the trailer, as long as they do not stick out of the lorry bed.

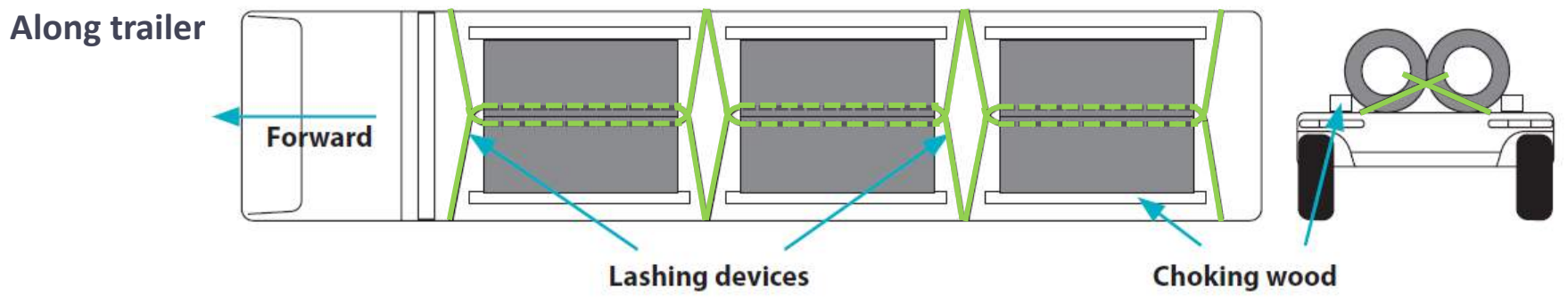
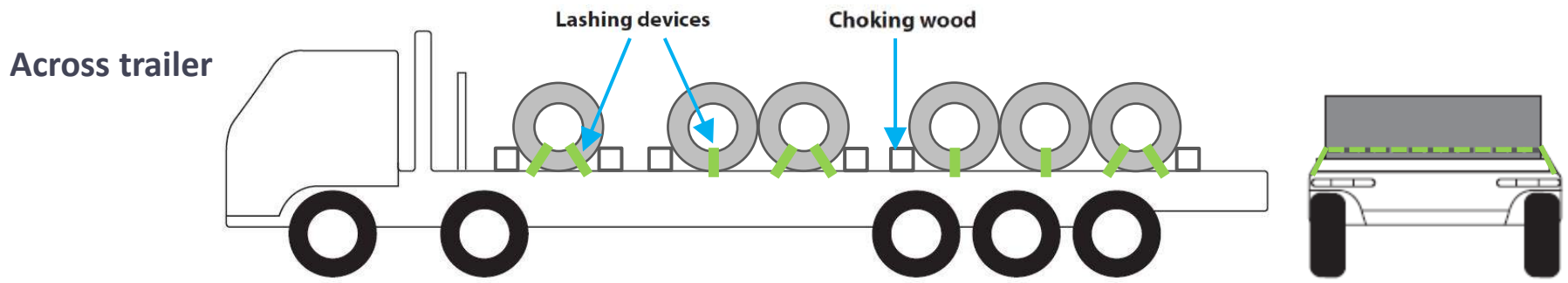

Metal sheet coils

Coils placed without pallets

- Load wider coils at the front
- Load coils neatly in a straight line and in contact
- Use choking wood between every coil to prevent rolling
(wood thickness should be at least 10cm by 10cm)
- Lash all coils down vertically, except the last coil
- Use two lashing devices on the last coil; one lash secured forward and the other lash secured backward

Insert company
logo



Metal sheet coils

Coils placed on pallets

- Secure coil to the pallet
- Pallets must be in contact with pallets beside it
- Lash the first and last rows to the vehicle
- Use loop lashing for better security

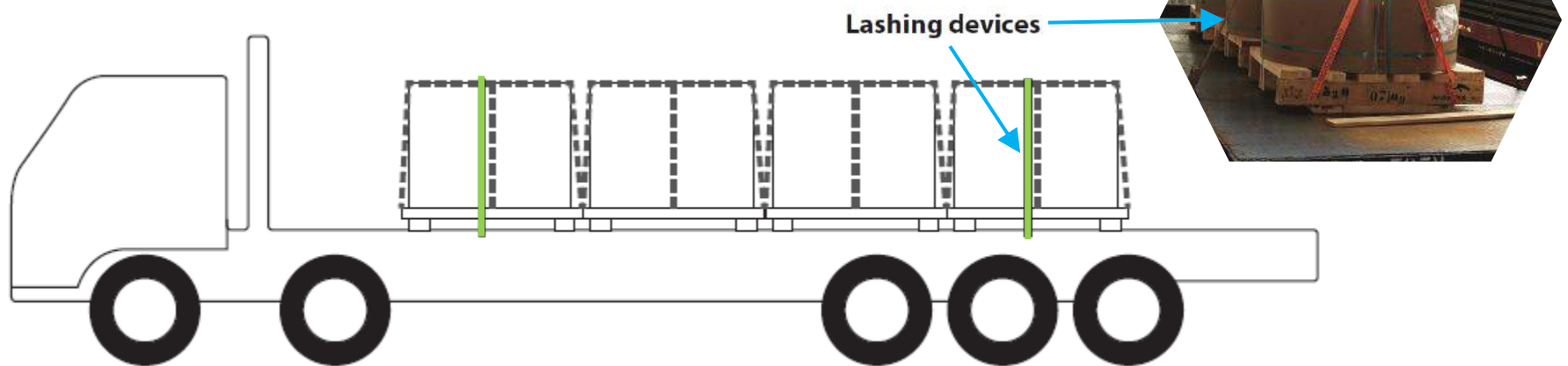

Insert company logo

Metal sheet coils

Coils placed on brackets

- Secure every row to the vehicle
- Use loop lashing or edge protection to better restrict movements



Brackets for securing coils

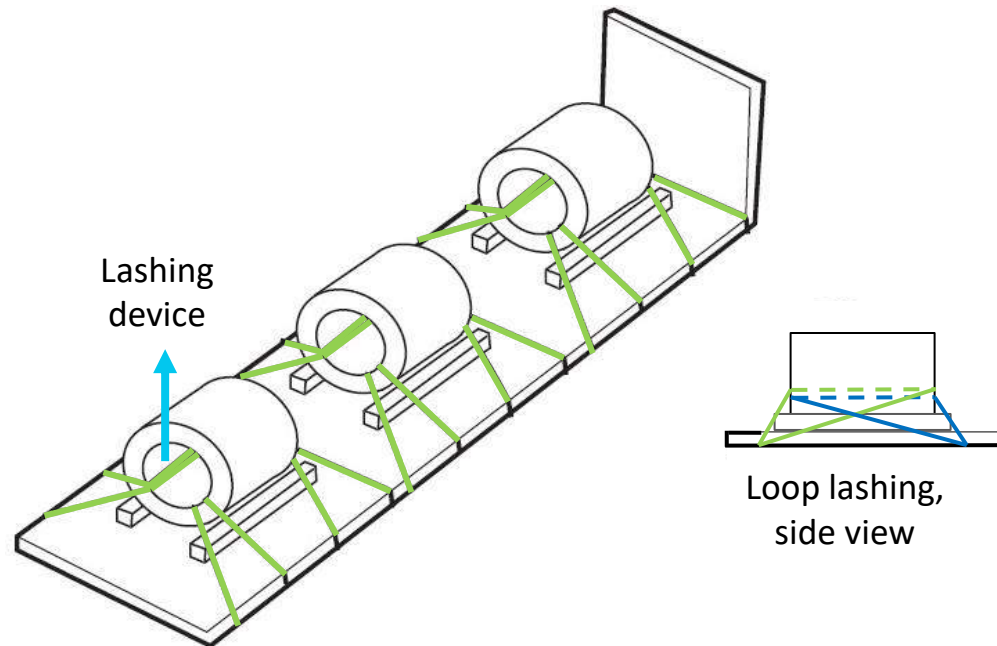

Insert company logo

Steel wire coils

- Load coil across the trailer
- Place wider coils at the front
- Load coils in a straight line and in contact
- Use chocking wood between every row
(at least 10cm by 10cm)
- Use two lashing devices each on the first and last coils



✗ Insufficient lashing & lack of chocking

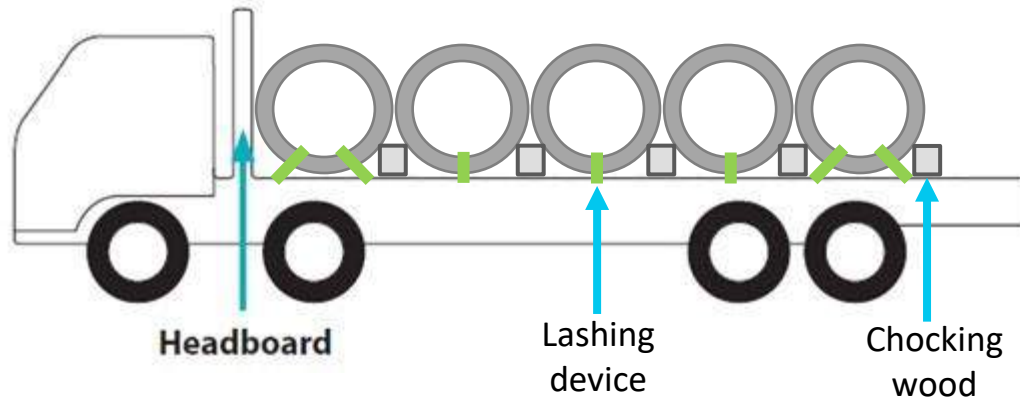

Insert company logo

Cable drums

- Load drum across the trailer
- Load wider drums at the front of the truck
- Load drums in a straight line and in contact
- Use choking wood between all drums
- Lash all drums vertically with steel chains
- Use two lashing devices on the last drum; one secured forward, and the other secured backward



X Insufficient lashing and containment

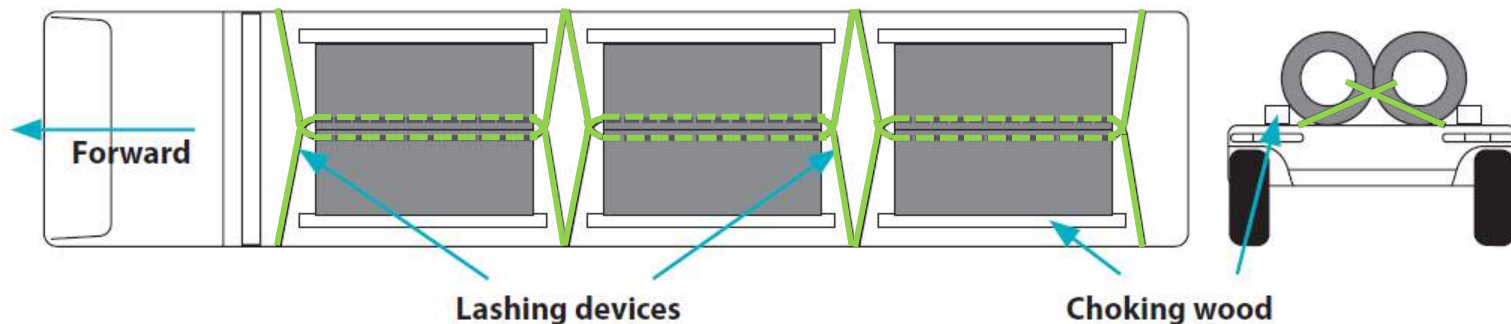

Metal panels

- Fit sideboards to prevent sideways movement
- Load cargo close to headboard to prevent forward movement
- Lash every row to the vehicle along the length and breadth of the vehicle



Insert company
logo

Scrap metal

- Load scrap metal into a container bin
- Avoid overloading the container
- Cover container bin with a canvas sheet or netting to prevent lighter cargo from falling out



Insert company
logo

Timber loads

- Choose a trailer that is longer than the loads
- Bundle loose timber at two ends
- Stack loads at a uniform height
- Use two lashing per stack when loads are taller than sideboard

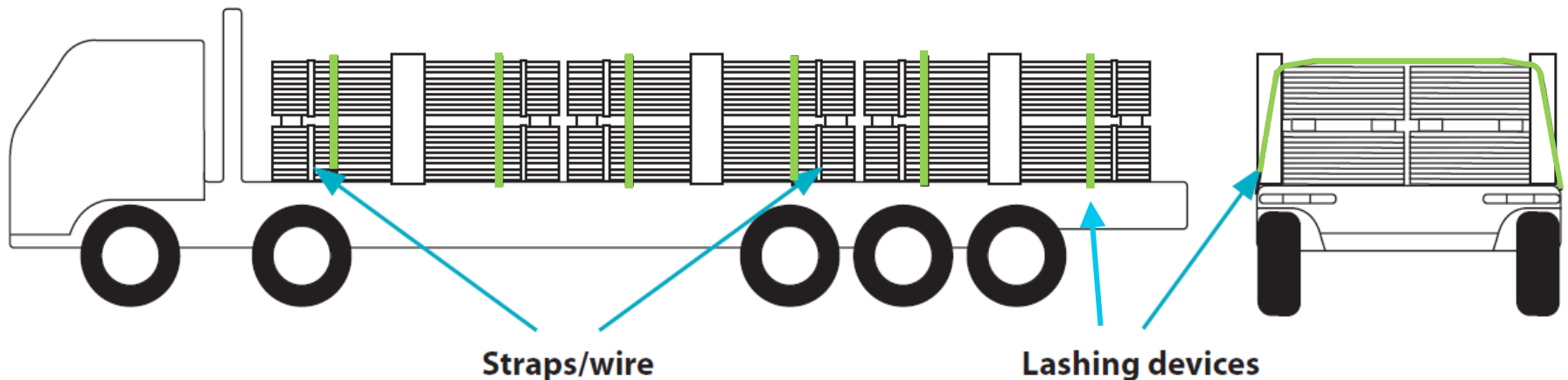

Insert company
logo

Heavy machines/ Equipments

- Use low bed trailers
- Remove loose dirt or grease from machine tracks before loading
- Position machines to minimize sections/components from sticking out of the trailer
- Apply parking brakes for wheeled or track machines
- Use chocking wood and lashing for better securing



Insert company
logo

Heavy machines/ Equipments

- Lash the machine according to manufacturer's instructions and movable parts down to prevent movement when transporting
- If instructions are not given, use lashing devices on non-movable parts of the machine to secure to vehicle
- Use the loop lashing method for more security
- Ensure that the machines don't exceed public road weight and height restrictions



Insert company
logo

Containers

- Use trailers fitted with at least four twist locks
- Check working condition of twist locks before use
- Secure twist locks immediately after loading



Twist lock in
locked position



Twist lock in
unlocked position

Insert company
logo

Precast

- Ensure weight is evenly distributed on the trailer
- Ensure that tallest point of the precast does not exceed traffic height limits (measured from ground level)
- Securing horizontally: use sling belts and stoppers
- Securing vertically: use galvanised wires and chain blocks
- Avoid overloading the trailer



Galvanised chains with hooks



Insert company
logo

Concrete blocks and slabs

- Ensure weight is evenly distributed on the trailer
- Do not stack slabs higher than headboard or tailboard, whichever is shorter
- Use 2 lashings for slabs up to 3m in length
- Use 1 additional lashing for every additional 3m in length

Tie-downs (2+1):

for every additional 3.02m (10ft) or part thereof
for cargo longer than 3.02m (10ft)-

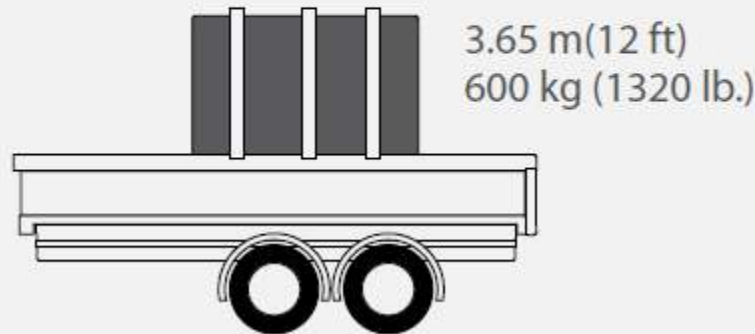

Insert company
logo

Jumbo bags

- Place bags close to the headboard
- Pack the bags tightly so they are in contact
- Stack only one layer of bags whenever possible
- Lash every row of bags

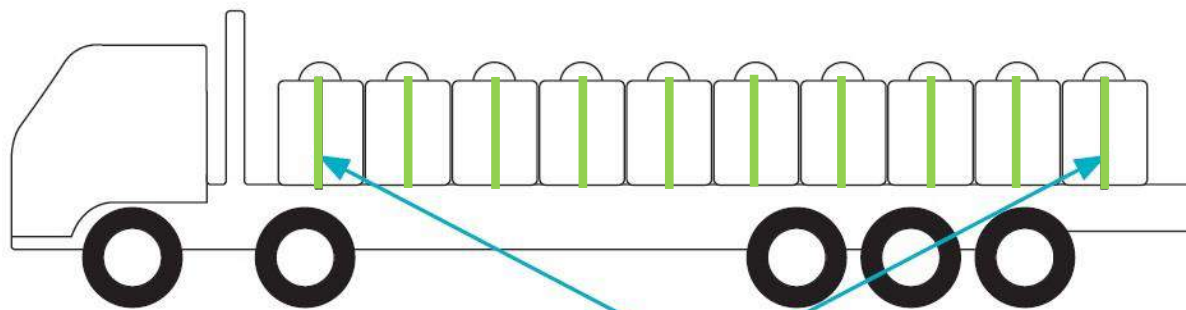

Lashing device

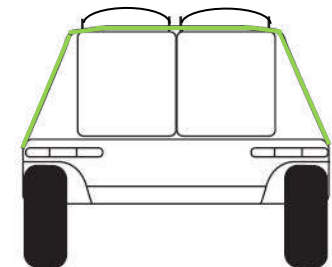

logo

Car transporters

- Apply brakes of vehicle after loading
- Secure vehicle according to vehicle manufacturers' instructions
- Use two wheel chokes at every wheel
- Lash the restraining points on the vehicle to the anchorage points on the transporter



Insert company
logo



Tote bins

- Place tote bins as close to the headboard as possible
- Minimise the spaces between the bins during loading
- Lash every row of bins



Insert company
logo

END

Insert company
logo



WSHCOUNCIL